



Meubles de Qualité à Prix Abordable
Affordable Quality Home Furniture

BIBLIOTHÈQUE 72" H HOLLOW-CORE BLANC
WHITE HOLLOW-CORE 72" H BOOKCASE

I 7071-1

INSTRUCTIONS D'ASSEMBLAGE
ASSEMBLY INSTRUCTIONS

MONARCH SPECIALTIES INC.





**POUR DE L'ASSISTANCE OU POUR COMMANDER
DES PIÈCES CONTACTEZ NOTRE DÉPARTEMENT
DE SERVICE À LA CLIENTÈLE.**

**FOR ASSISTANCE OR TO ORDER PARTS
CONTACT OUR CUSTOMER SERVICE DEPARTMENT**

WWW.MONARCHSERVICE.COM

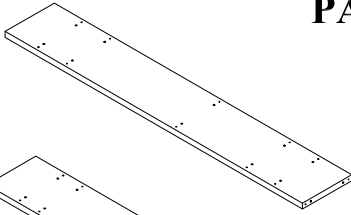
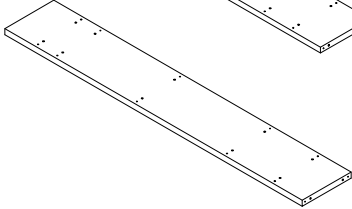
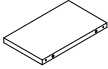
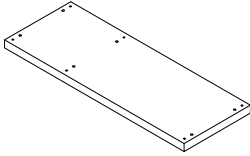
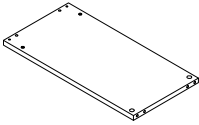
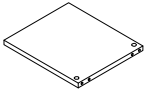
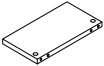

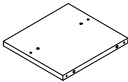
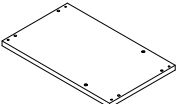
IDENTIFICATION DES PIÈCES
PARTS IDENTIFICATION

1		PANNEAU CÔTÉ GAUCHE LEFT SIDE PANEL	1MC 1PC
2		PANNEAU CÔTÉ DROIT RIGHT SIDE PANEL	1MC 1PC
3		PANNEAU DE DIVISION DIVIDER PANEL	4MCX 4PCS
4		PANNEAU DU DESSUS TOP PANEL	2MCX 2PCS
5		PLAQUE TRANSVERSALE CROSS BRACE	1MC 1PC
6		PLAQUE TRANSVERSALE CROSS BRACE	1MC 1PC
7		PLAQUE TRANSVERSALE CROSS BRACE	2MCX 2PCS
8		PLAQUE TRANSVERSALE CROSS BRACE	2MCS 2PCS
9		PANNEAU DE DIVISION DIVIDER PANEL	5MCX 5PCS
10		PANNEAU DE DIVISION DIVIDER PANEL	3MCX 3PCS

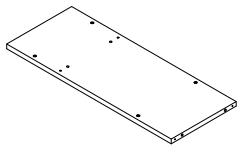
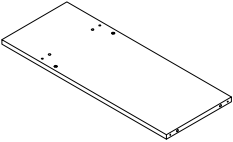
IDENTIFICATION DES PIÈCES
PARTS IDENTIFICATION

11		PLAQUE TRANSVERSALE CROSS BRACE	1MC 1PC
12		PLAQUE TRANSVERSALE CROSS BRACE	1MC 1PC

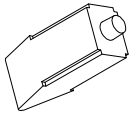
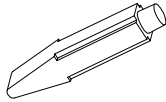
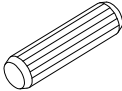
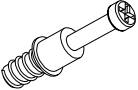
IDENTIFICATION DES PIÈCES DE MONTAGE
HARDWARE IDENTIFICATION

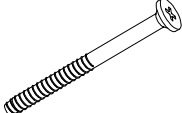
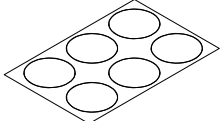
A		COLLE/GLUE(40g)	1MC / PC
B		COLLE/GLUE(15g)	1MC / PC
C		$\phi 8 \times 30\text{mm}$	74MCX / PCS
D		35mm	12MCX / PCS
E		$\phi 15 \times 12\text{mm}$	12MCX / PCS
F		42mm	42MCX / PCS
G		55mm	20MCX / PCS
H		$\phi 20\text{mm}$	13MCX / PCS

ÉTAPE / STEP 1

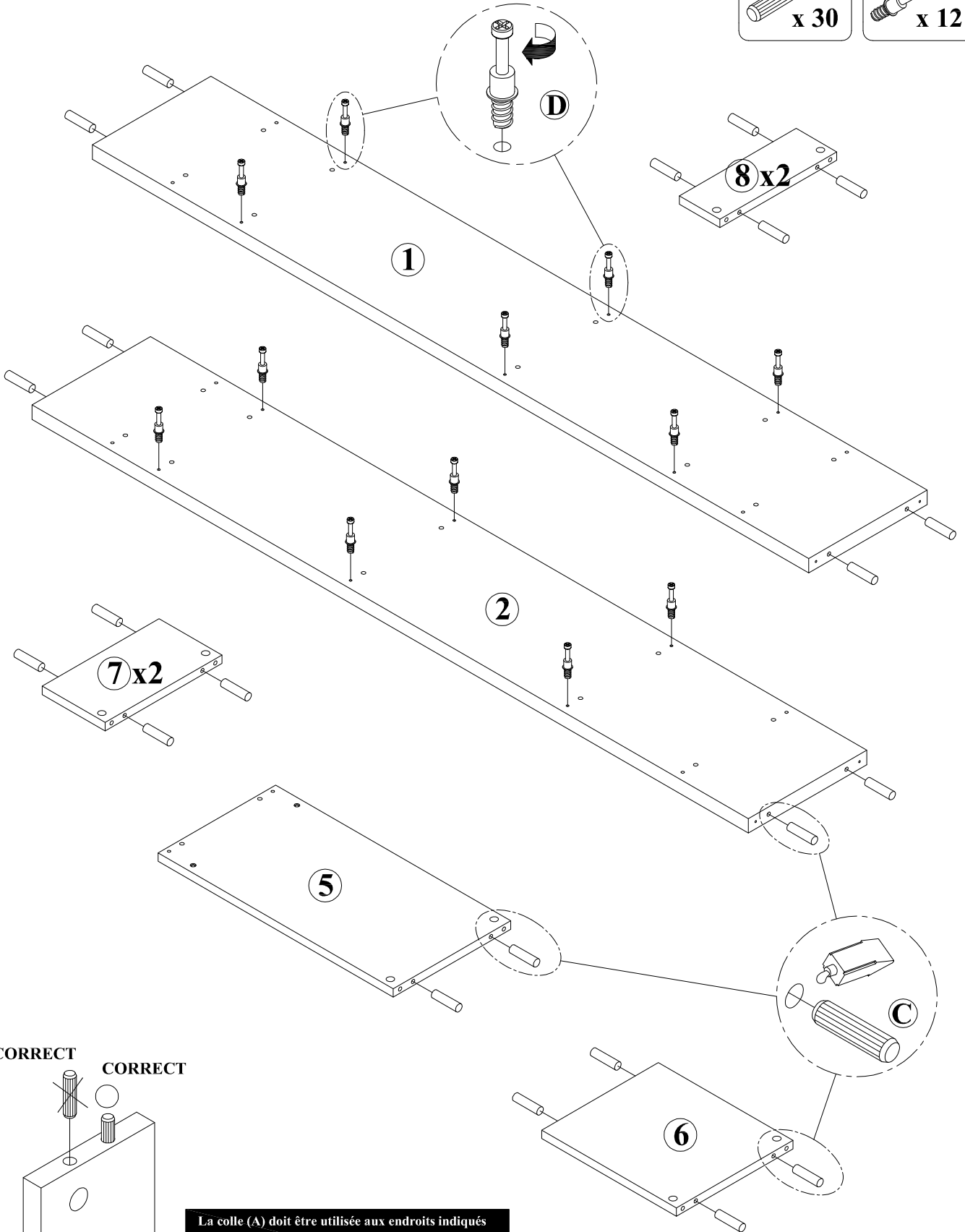
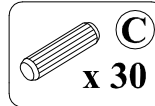

INCORRECT CORRECT

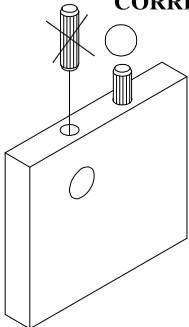

La colle (A) doit être utilisée aux endroits indiqués
 afin de solidifier l'étagère assemblée.
 The Glue (A) should be used in the indicated
 locations to help solidify the assembled unit.

ÉTAPE / STEP 2

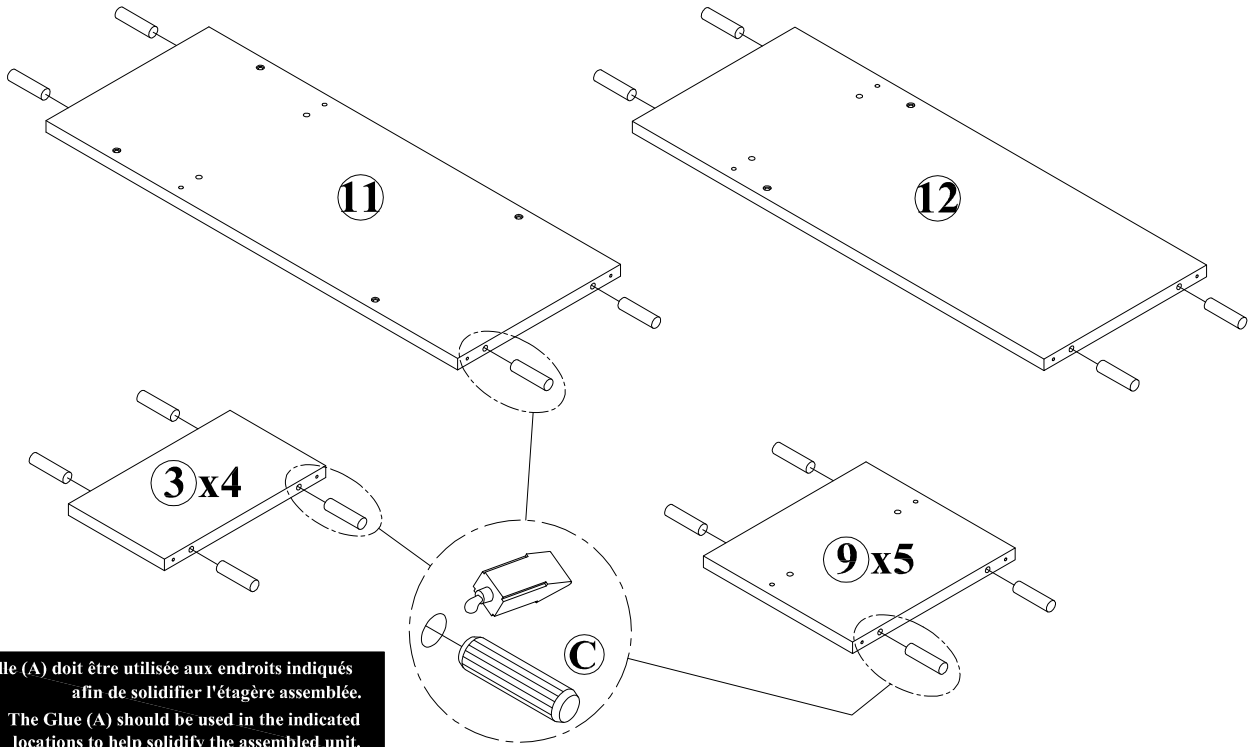
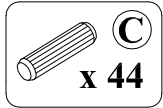

La colle (A) doit être utilisée aux endroits indiqués afin de solidifier l'étagère assemblée.
 The Glue (A) should be used in the indicated locations to help solidify the assembled unit.

ÉTAPE / STEP 3

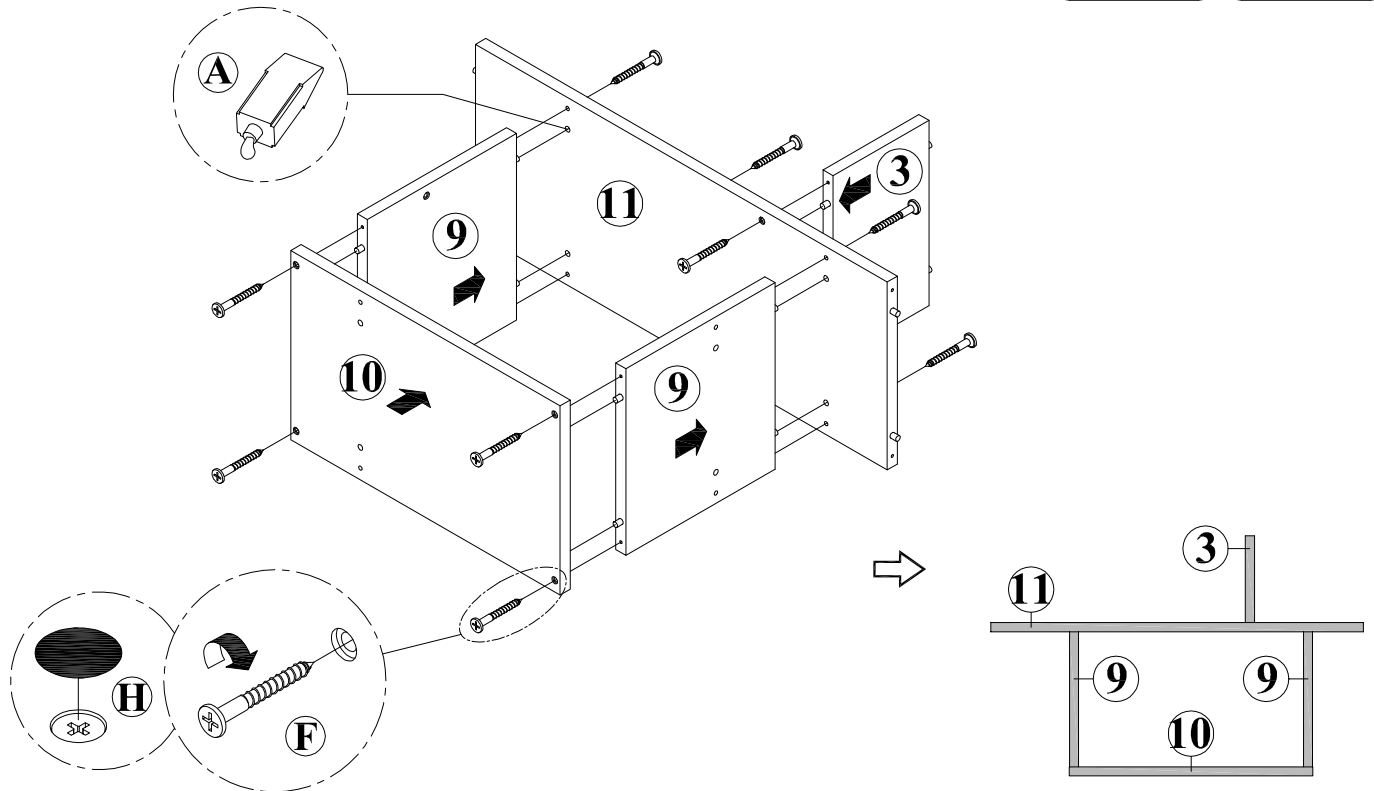
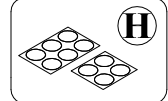
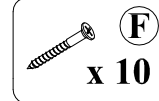

ÉTAPE / STEP 4

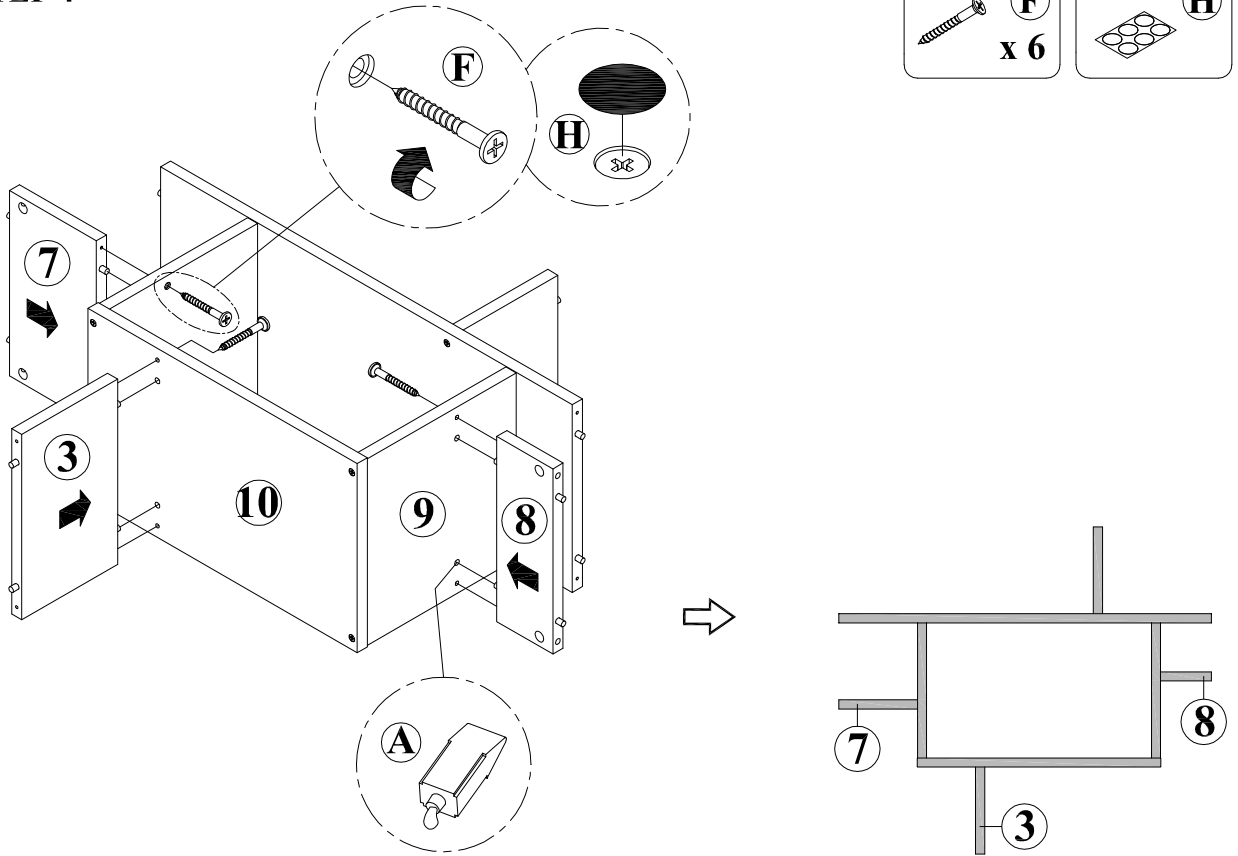

ÉTAPE / STEP 5

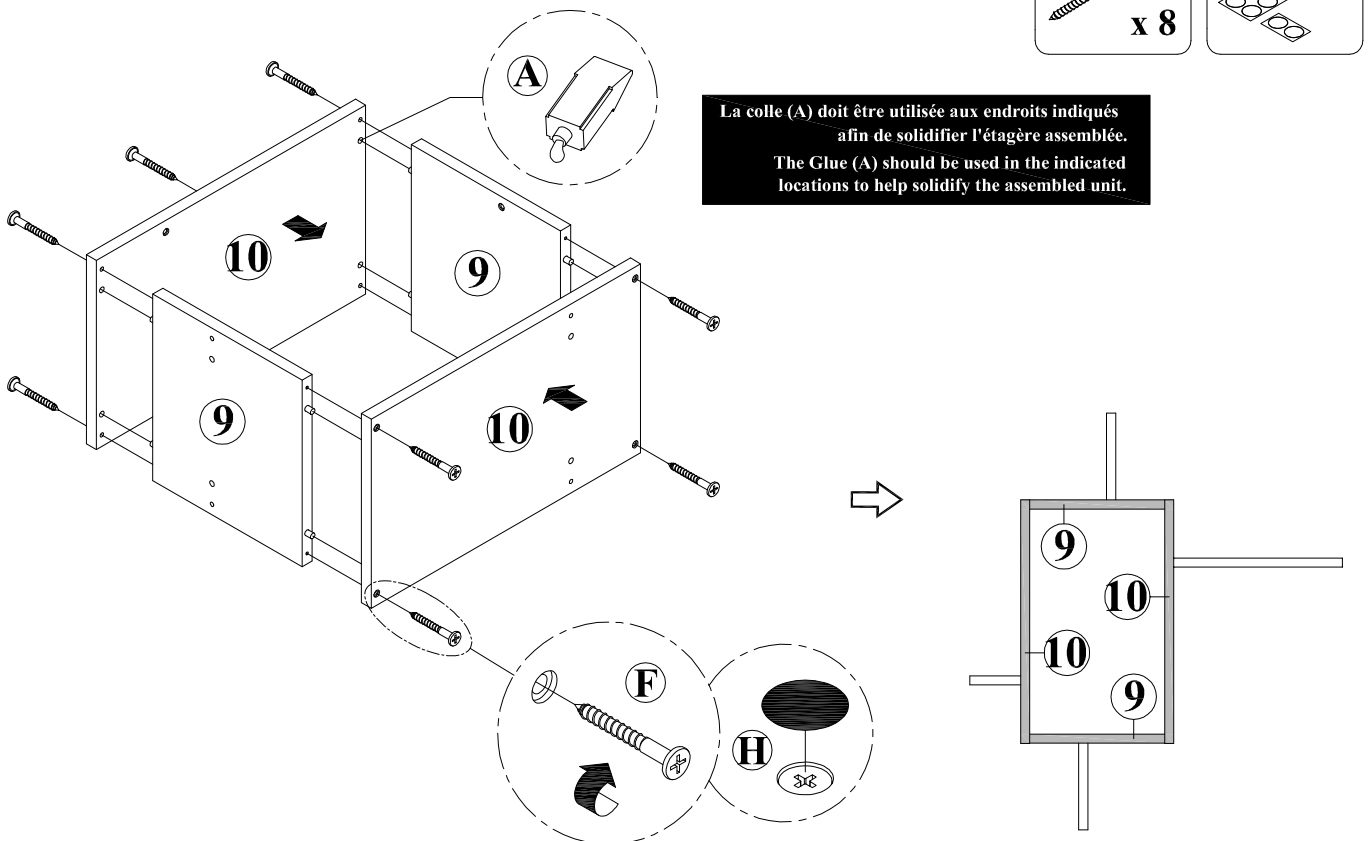

ÉTAPE / STEP 6

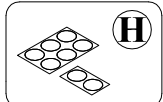
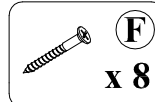
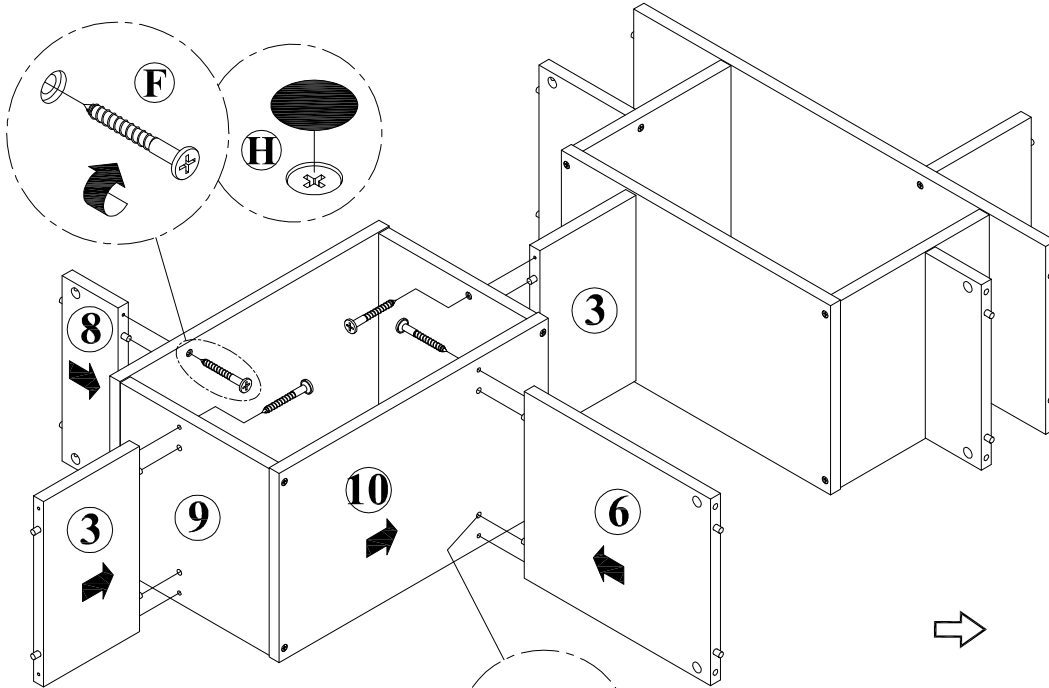

La colle (A) doit être utilisée aux endroits indiqués afin de solidifier l'étagère assemblée.
 The Glue (A) should be used in the indicated locations to help solidify the assembled unit.

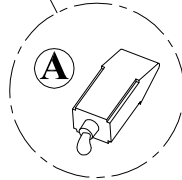

ÉTAPE / STEP 7

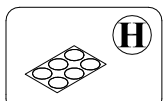
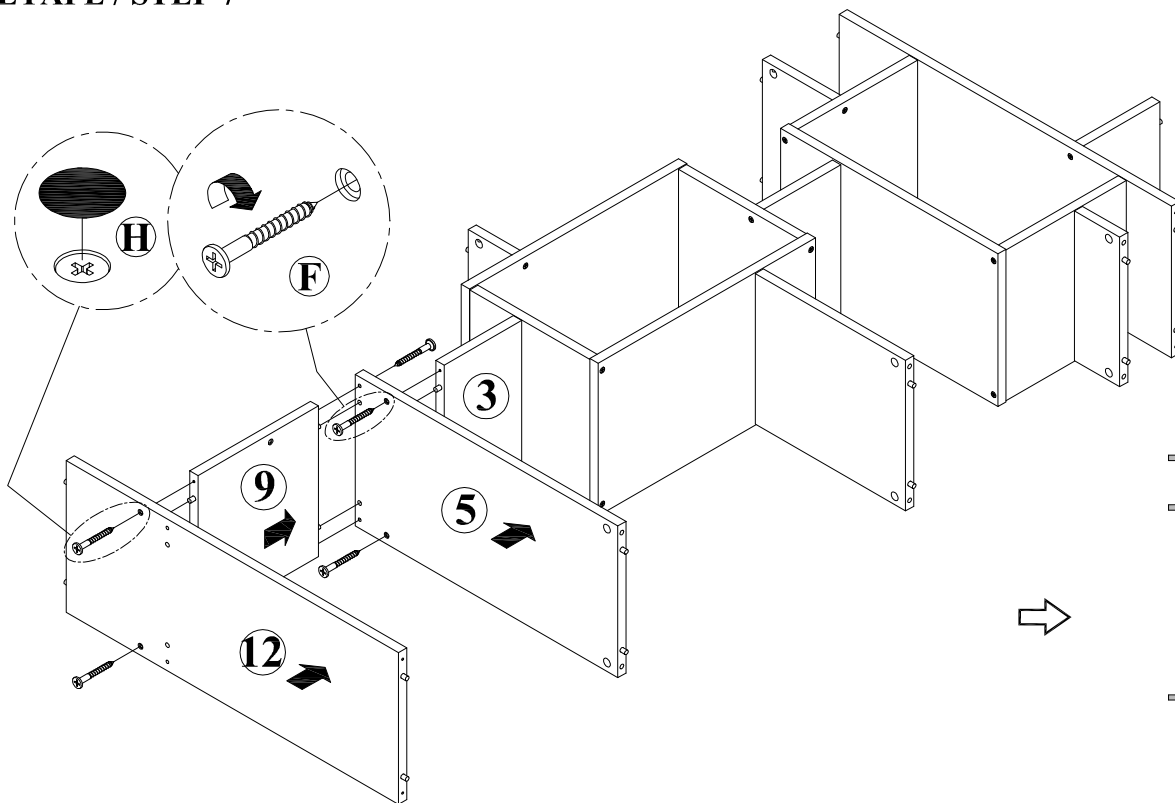

ÉTAPE / STEP 8

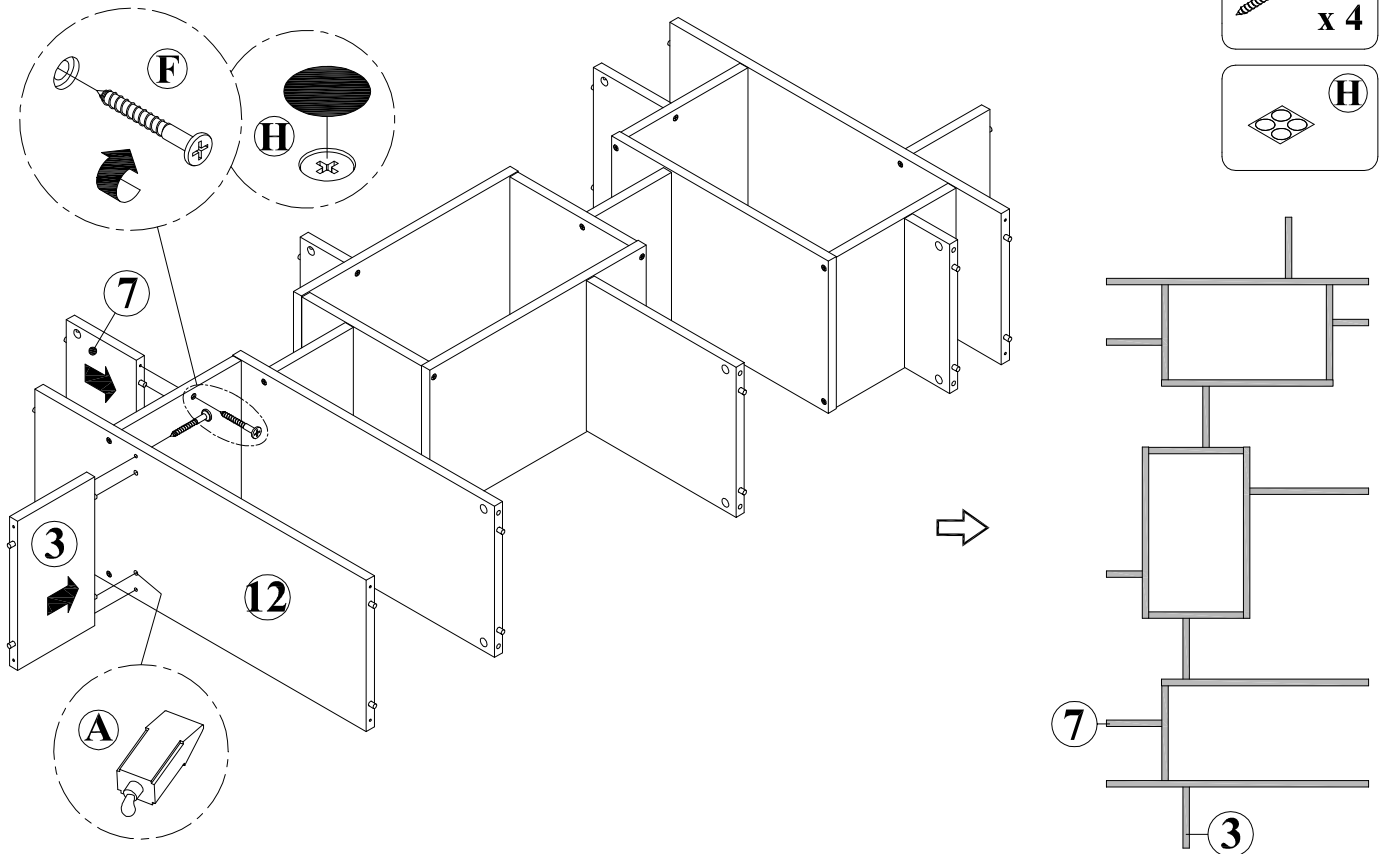

ÉTAPE / STEP 9

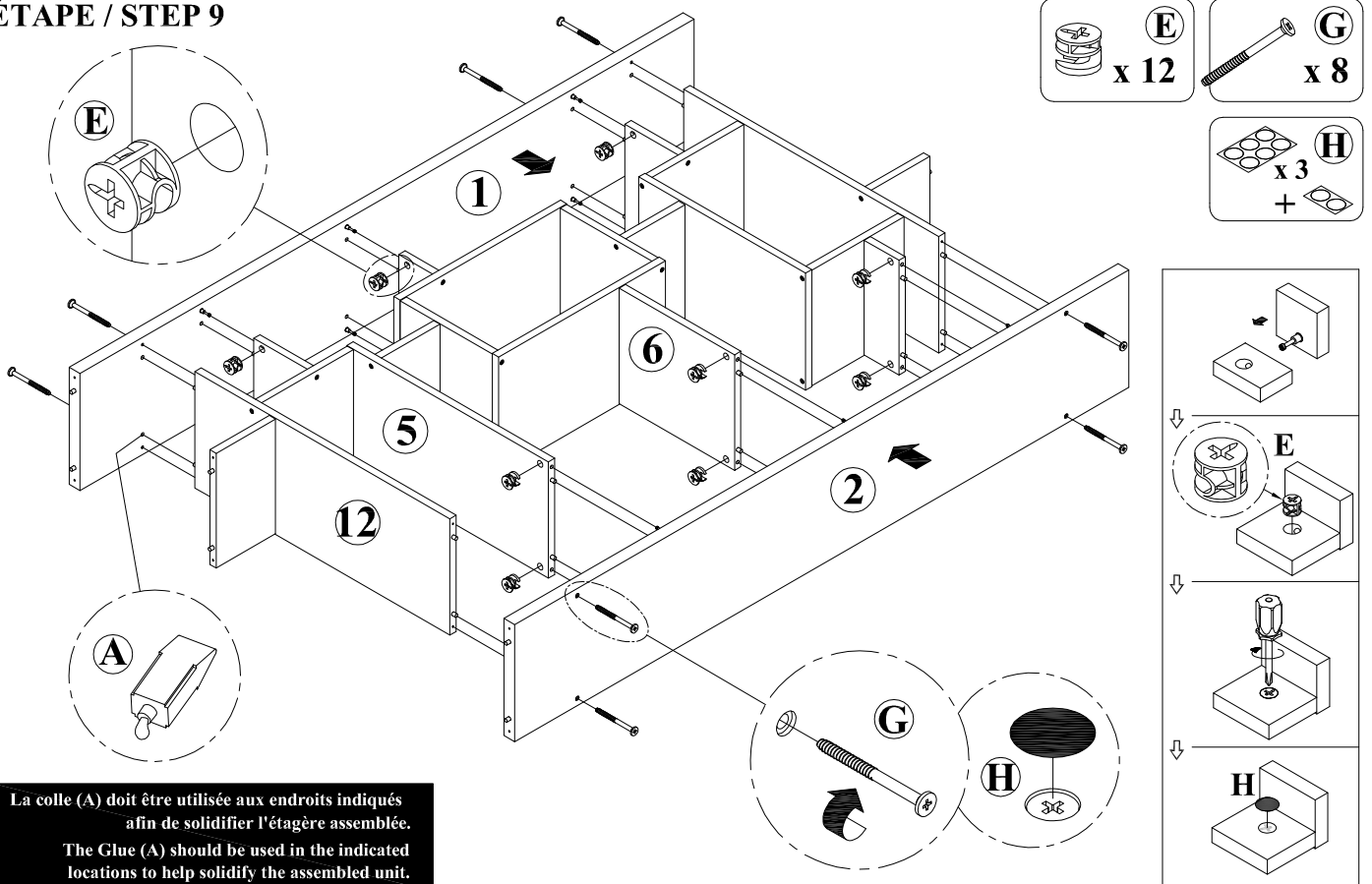

La colle (A) doit être utilisée aux endroits indiqués afin de solidifier l'étagère assemblée.
 The Glue (A) should be used in the indicated locations to help solidify the assembled unit.

ÉTAPE / STEP 10

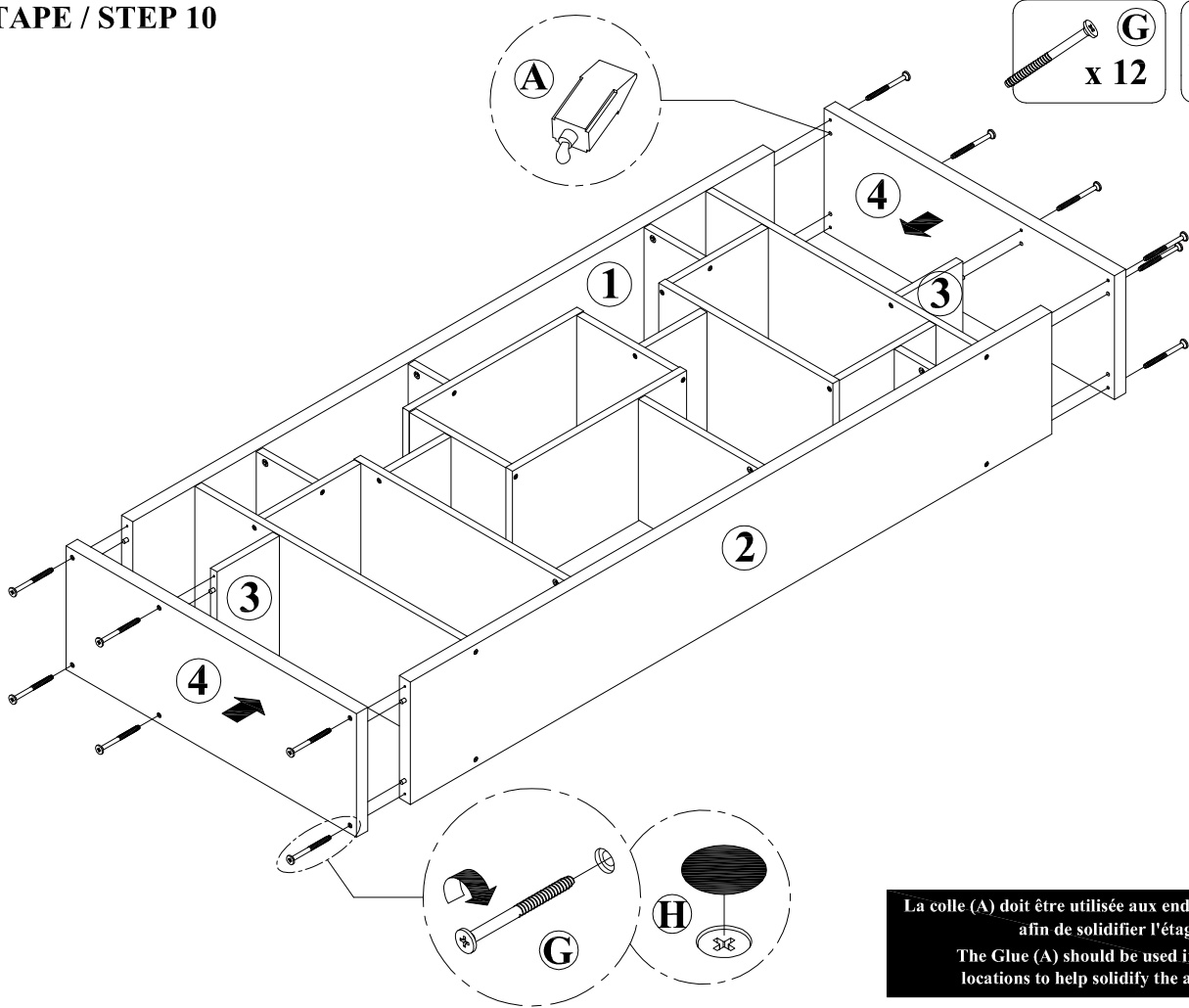

La colle (A) doit être utilisée aux endroits indiqués afin de solidifier l'étagère assemblée.
The Glue (A) should be used in the indicated locations to help solidify the assembled unit.

TERMINER / FINISH

